

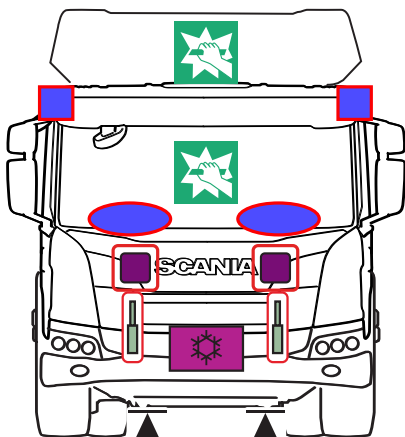

Scania 6x2 L  
Compressed natural gas (CNG)

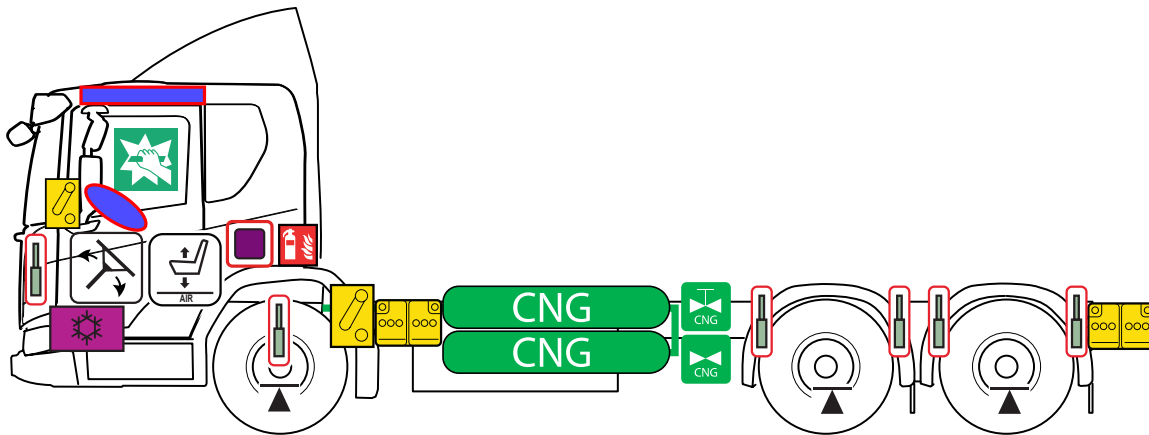
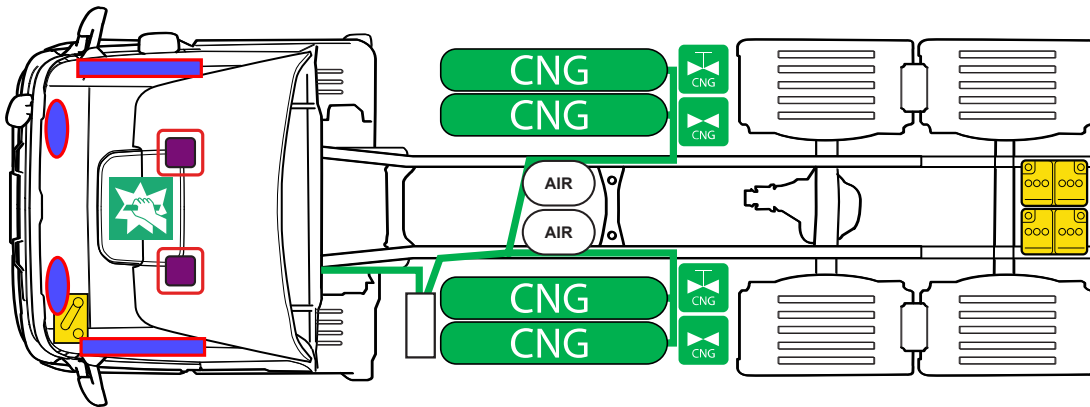

Printed matter No.  
00:01-128

Printed matter issue.  
1

	Compressed natural gas (CNG)		Low voltage battery, 24V		Manual shut of valve		Seat belt pretensioner		Pressure relief valve
	Lifting point		Break to obtain access		Air tank		Triggered gas strut, triggered preloaded spring		Fire extinguisher
	Airbag		Seat adjustment		Steering wheel tilt control		Emergency exit		Device to shut down power in vehicle, 24V
	Air-conditioning component		Gas line						

# 1. Identifiers



CAB SIZE



# 2. Immobilisation / stabilisation / lifting

1. Activate the parking brake.

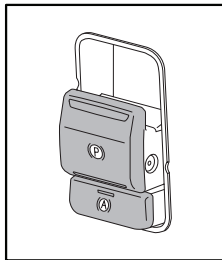

2. Lifting points

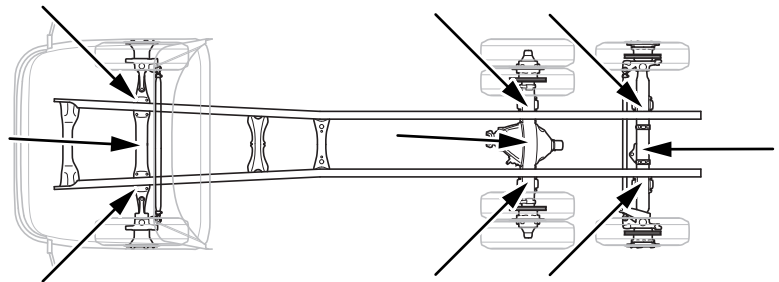

# 3. Disable direct hazards / safety regulations

1. The low voltage battery switch (A) is located on the instrument panel\*. (\* On the drivers side.)  
If there are no low voltage battery switches, the low voltage is disconnected at the battery poles.

2. Shut of the CNG-tanks shut off valves (B). There is a valve on each tank.

A.

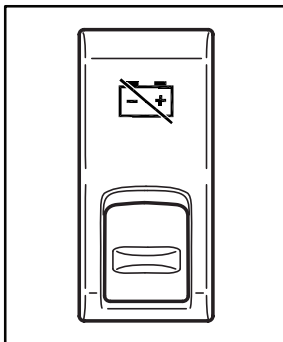

B.

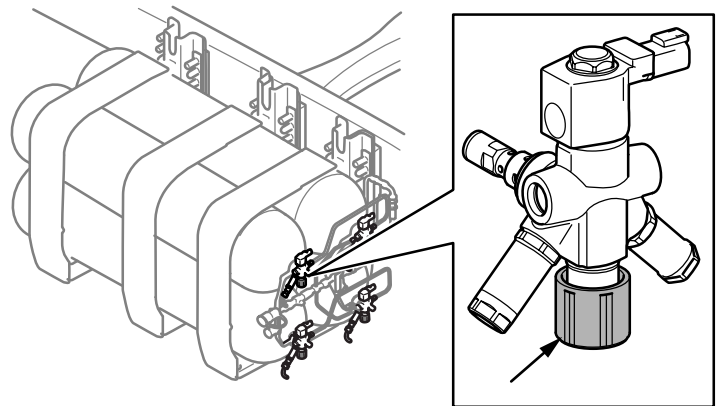

# 4. Access to the occupants

1. Through driver or passanger door.

2. Break through the side window.

*Note! Front windscreen is laminated.*

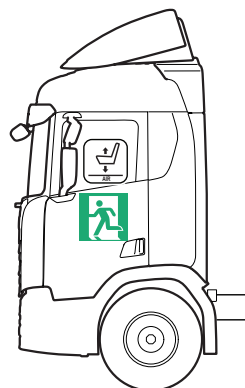
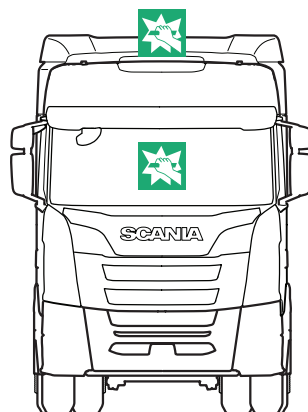

## 5. Stored energy / liquids / gases / solids

Normal CNG tank pressure is up to 230 bar.  
Explosive risk in excess over 450 bar.



Large CNG leaks can be identified by a whistling sound, gas smell or white frost around the leak area. Small leaks can be detected with a gas detection device.



Never perform work on a CNG truck with fuel leak without appropriate personal protective equipment (PPE)

### Other liquids and gases



## 6. In case of fire

The risk of explosion is very small. Temperature fuses (B) are automatically triggered at 110° C in order to prevent explosion. If the vehicle is equipped with a pressure fuse (A), this triggers at 240 bar. Explosive risk in excess of 450 bar.

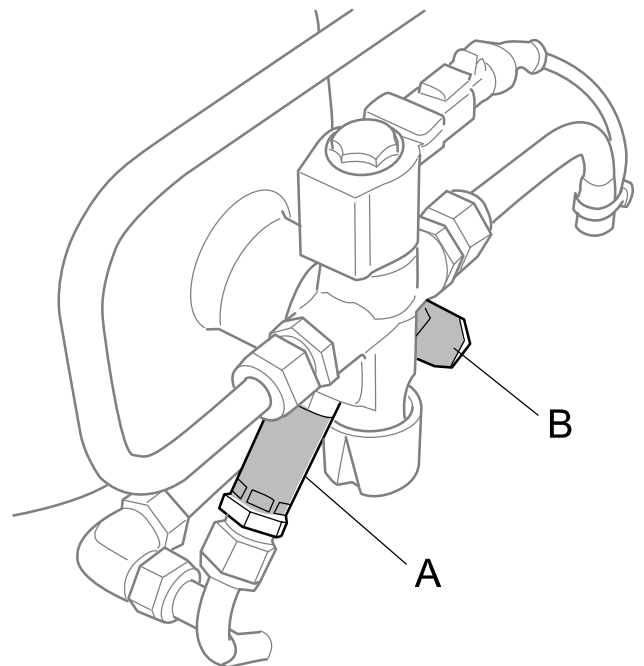
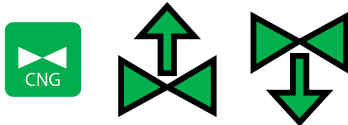

Reduce the risk of increased pressure in the tank by cooling the CNG tank with water.



Do not attempt to extinguish a fire involving CNG before the source of the fuel has been shut off.

### II. Fire related to other material



Can occur in the following compartments:  
- auxiliary heater.



If other materials are involved, a class ABC fire extinguisher can be used.

## 7. In case of submersion



If possible:

1. Remove the vehicle from the water.
2. Disable direct hazards (see section 3. Disable direct hazards / safety regulations).



Wear appropriate Personal Protective Equipment (PPE).

## 8. Towing / transportation / storage



Store the vehicle at a safe distance from other vehicles, buildings and combustible objects.



Do not tow a CNG powered truck if there is a CNG leak.

1. The towing eye fastening point is located under the front bumper



2. Shut down the power of the vehicle (See section 3. Disable direct hazards / safety regulations).
3. Keep away from inflammable and explosive materials.

Allowed methods:

1. Towing.

(Note! Use only front towing eye for towing the vehicle with all wheels on the ground).

2. Lifting and towing
3. Transporting

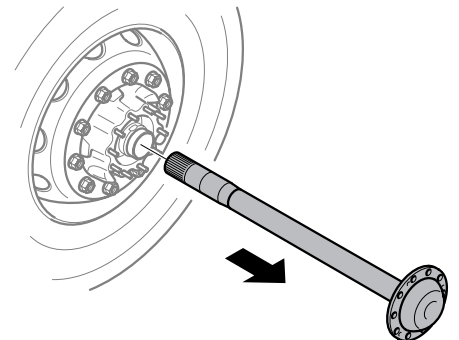
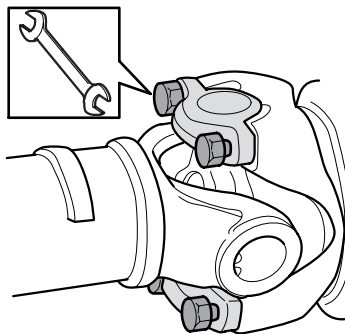
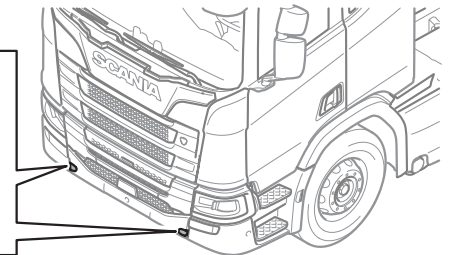
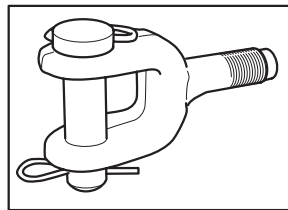

**Note!**

*If the vehicle must be towed or transported more than 500 m, the speed must not exceed 10 km/h.*

*Remove the drive shaft flange and the haft shaft from the drive axle.*

*(See drivers manual for detailed information).*

## 9. Important additional information



See drivers manual or rescue and towing manual for more detailed information

## 10. Explanation of pictograms used

N/A