

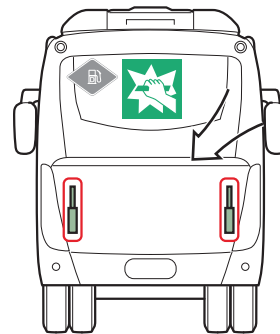

Scania A30 ICE diesel bus

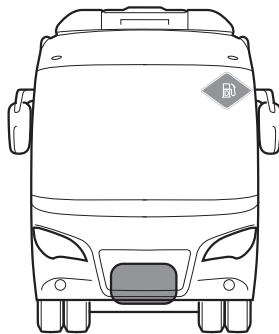
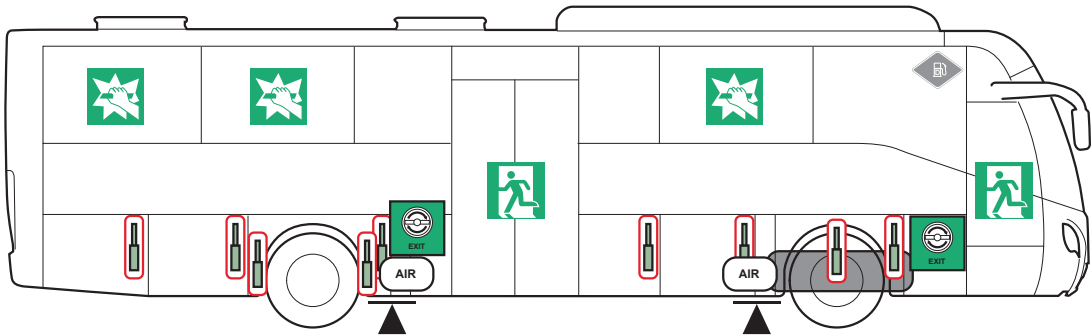
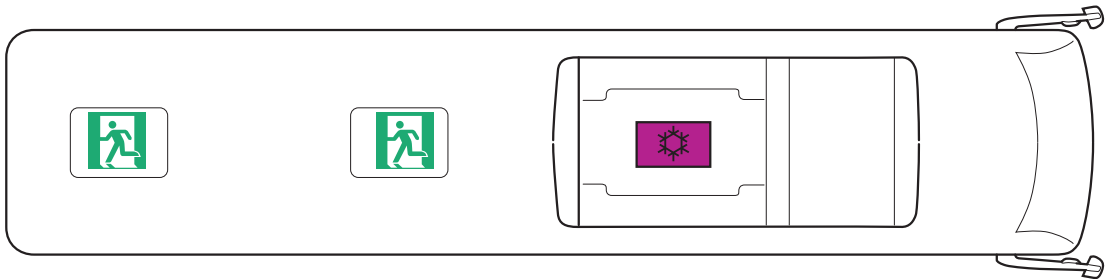
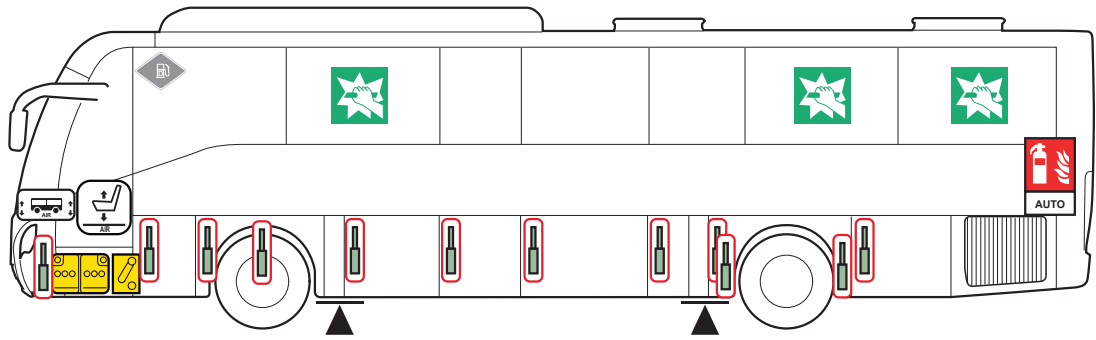
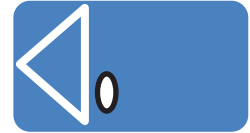

	Diesel		Low voltage battery, 24V		Device to shut down power in vehicle, 24V		Height control		Seat adjustment
	Lifting point		Auto fire suppression		Air-conditioning component		Air tank		Fuel tank. Diesel or biodiesel
	Emergency exit		Break to obtain access		Emergency door opening		Triggered gas strut, triggered preloaded spring		Fire extinguisher
	Engine compartment ventilation								

1. Identifiers



2. Immobilisation / stabilisation / lifting

1. Activate the parking brake.

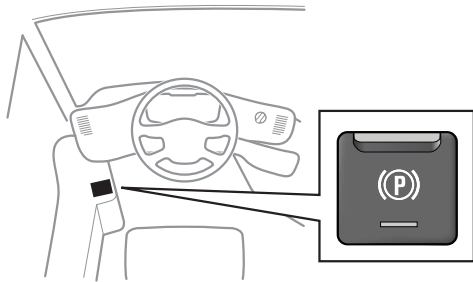

2. Lifting points

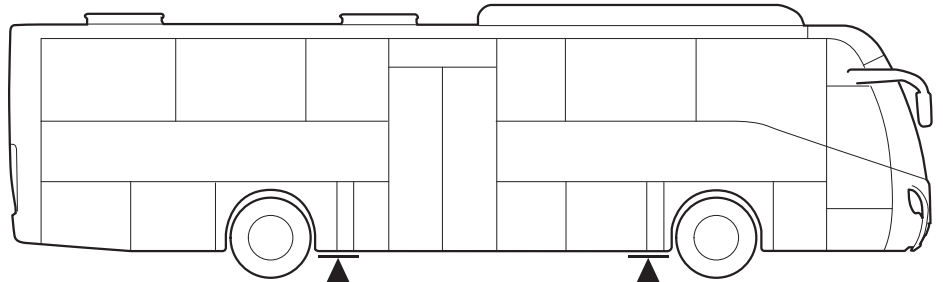

3. Disable direct hazards / safety regulations

Activate the manual battery master switch when the vehicle is to be parked for a longer period.

1. Shut off the engine using the starter key.
2. Disconnect the batteries using the electrical battery master switch (A).
3. wait at least 3 minutes. Several systems need time to shut down properly.
4. Disconnect the batteries using the manual battery master switch (B).

The batteries are now completely disconnected from all systems on the body and chassis

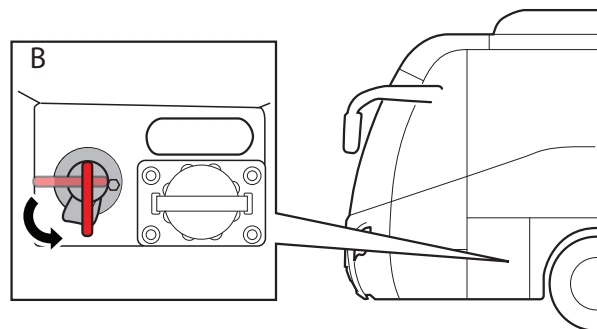
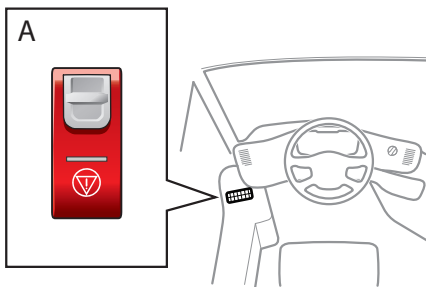

4. Access to the occupants

1. Through passenger door.
2. Break through the side window.

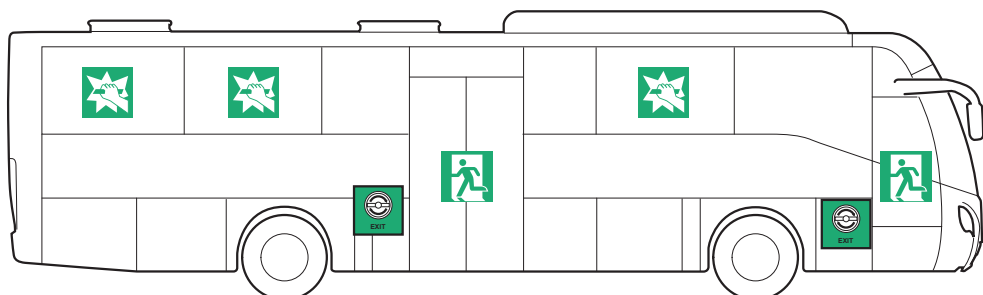

5. Stored energy / liquids / gases / solids

1. Diesel fuel vehicle.
2. Beware of flammable, explosive, corrosives, acute toxicity, environmental hazards, electricity.
3. Other liquids/gases

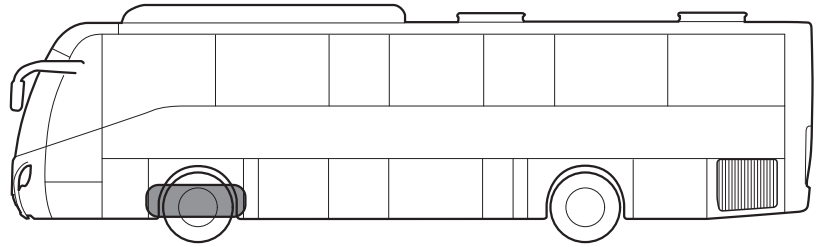

* Amount of fuel tanks and fuel volume may vary depending on configuration.

6. In case of fire.

1. Open flap, press the safety valve and open the door to escape.

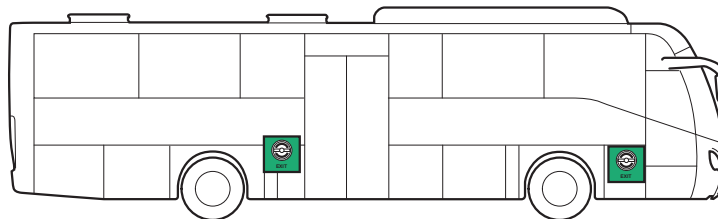
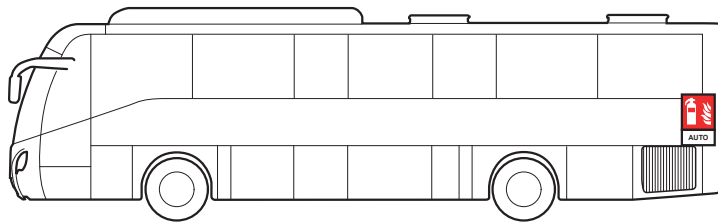

2. Use water to extinguish the fire. When fighting the fire with water, any electrical hazards must be considered and local regulations adhered to.



3. Use ABC powder to extinguish the fire.



4. Indicate that a thermal infrared camera should be used to detect a fire.

7. In case of submersion

If possible:

1. Remove the vehicle from the water.
2. Disable direct hazards (see section 3. Disable direct hazards / safety regulations).

8. Towing / transportation / storage

1. The towing eye fastening point is located under the front bumper.



2. Shut down the power of the vehicle
(See section 3. Disable direct hazards / safety regulations).
3. Keep away from flammable and explosive materials.

Allowed methods:

1. Towing.
Note! Only use front towing eye for towing the vehicle with all wheels on the ground.
2. Lifting and towing.
3. Transporting.

Note!

*If the vehicle must be towed more than 500m!
Remove the drive shaft flange and the haft shaft from the drive axle.
(See drivers manual for detailed information)*

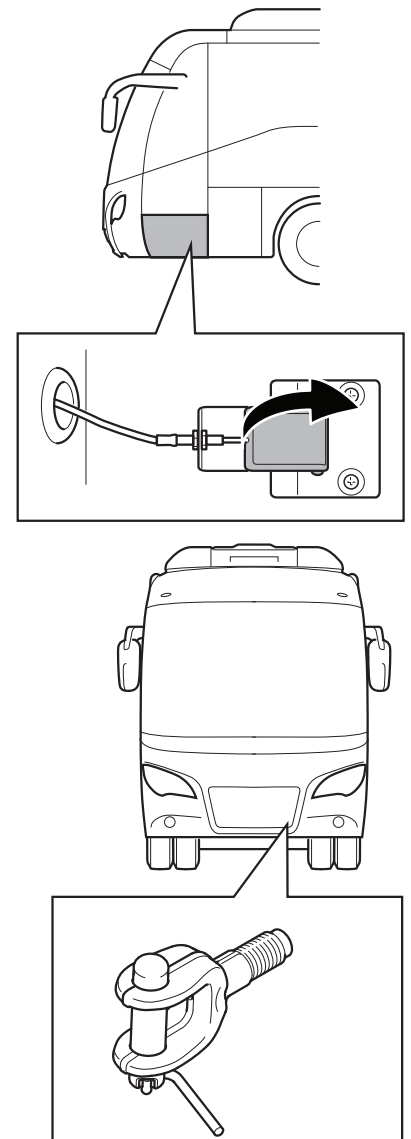

9. Important additional information

N/A

10. Explanation of pictograms used

N/A