

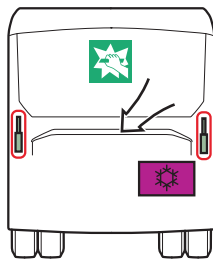

Scania 6x2/2 LE ICE diesel bus

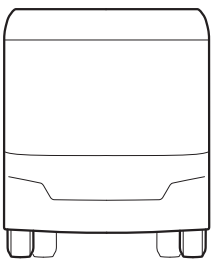
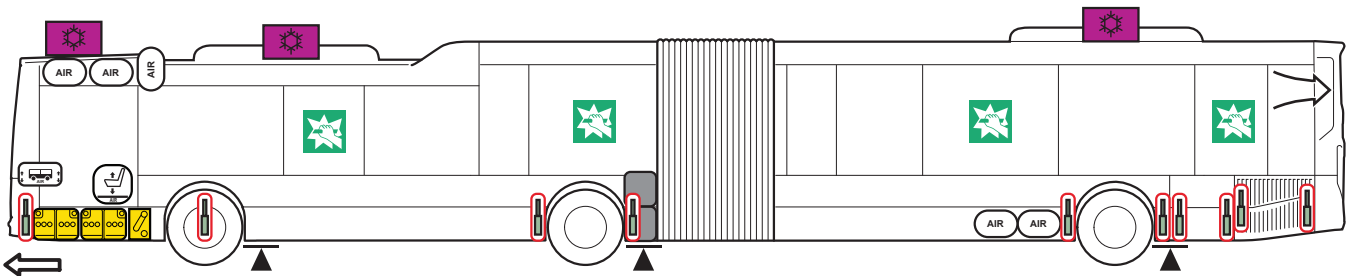
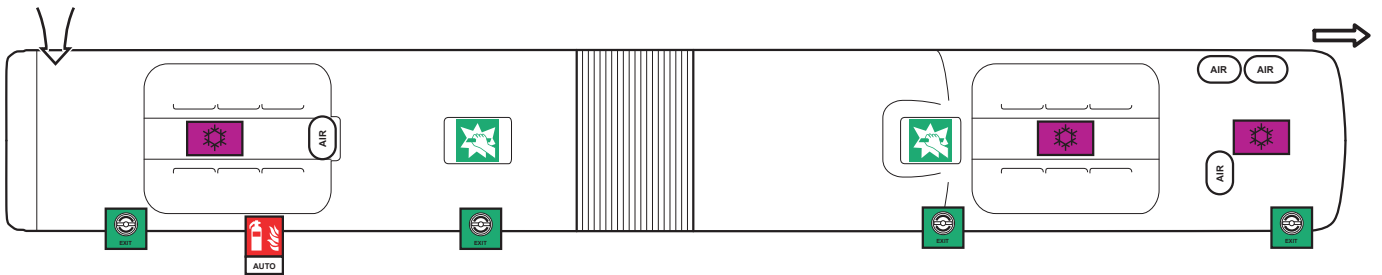
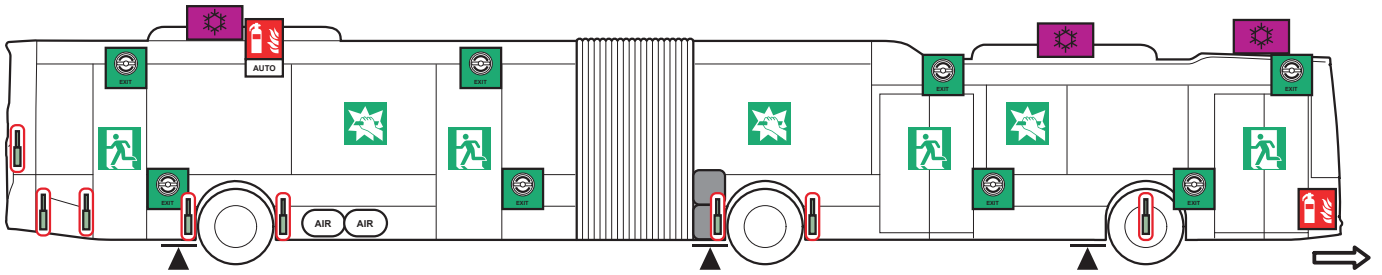

	Diesel		Low voltage battery, 24V		Device to shut down power in vehicle, 24V		Height control		Seat adjustment
	Lifting point		Auto fire suppression		Air-conditioning component		Air tank		Fuel tank. Diesel or biodiesel
	Emergency exit		Break to obtain access		Emergency door opening		Triggered gas strut, triggered preloaded spring		Fire extinguisher
	Engine compartment ventilation								

# 1. Identifiers



# 2. Immobilisation / stabilisation / lifting

1. Activate the parking brake.

2. Lifting points

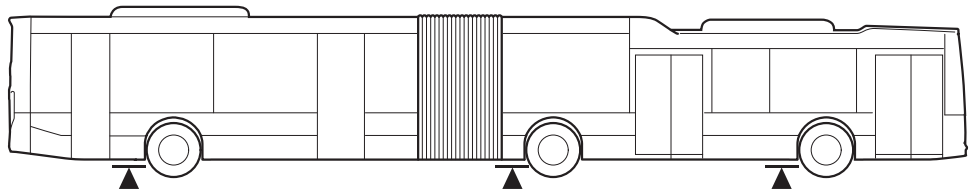
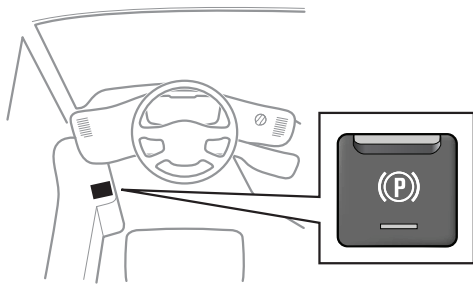

# 3. Disable direct hazards / safety regulations

1. The power switch for turning off all electric power in the vehicle is located in one of below specified locations.  
The low voltage battery switches (A and B) are optional and are located as indicated below.  
If there are no low voltage battery switches, disconnect the connectors at the low voltage battery terminals.

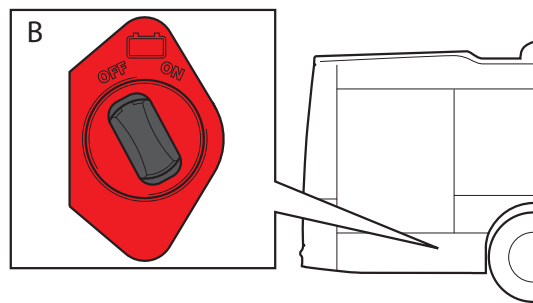
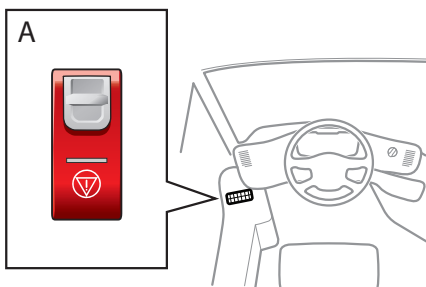

# 4. Access to the occupants

- 1. Through passenger door.
- 2. Break through the side window.

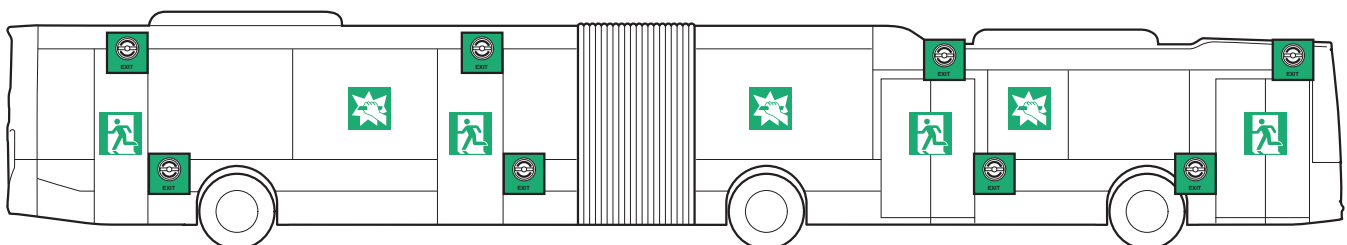

## 5. Stored energy / liquids / gases / solids

1. Diesel fuel vehicle.
2. Beware of flammable, explosive, corrosives, acute toxicity, environmental hazards, electricity .
3. Other liquids/gases

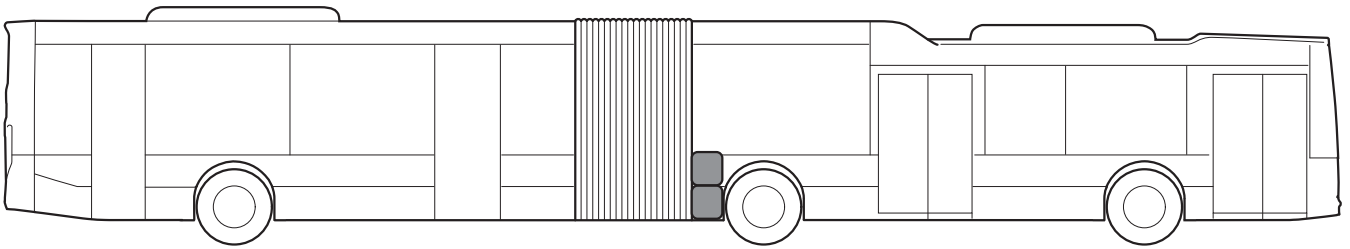

\* Amount of fuel tanks and fuel volume may vary depending on configuration.



## 6. In case of fire.

1. Open flap, press the safety valve and open the door to escape.

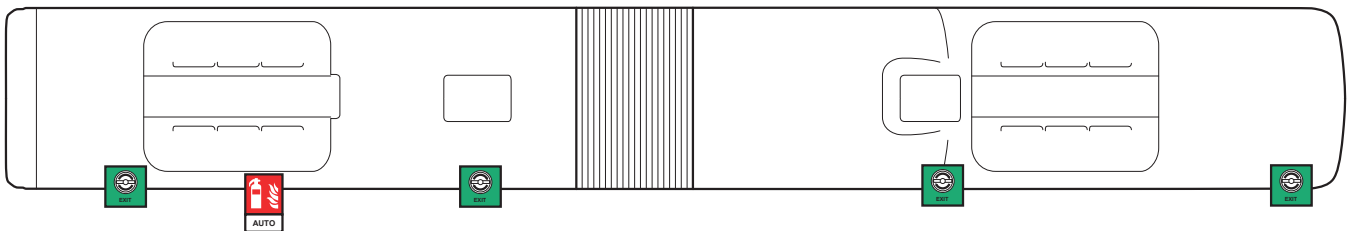
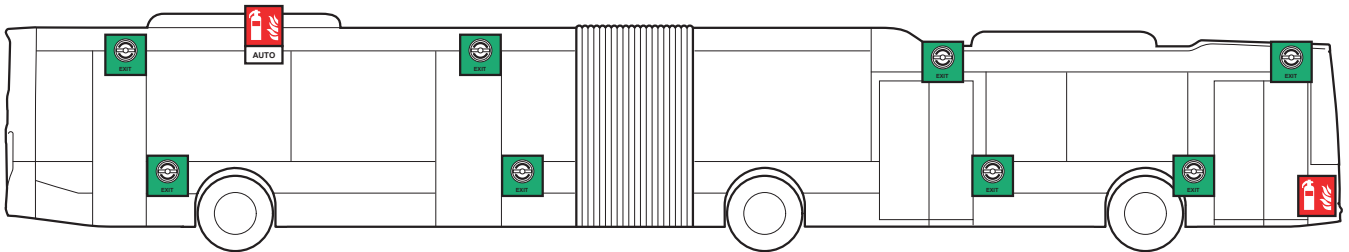

2. Use water to extinguish the fire. When fighting the fire with water, any electrical hazards have to be considered and rules have to be respected.



3. Use ABC powder to extinguish the fire.



4. To indicate that a thermal infrared camera should be used to detect a fire.

## 7. In case of submersion

If possible:

1. Remove the vehicle from the water.
2. Disable direct hazards (see section 3. Disable direct hazards / safety regulations).

## 8. Towing / transportation / storage

1. The towing eye fastening point is located under the front bumper.



2. Shut down the power of the vehicle  
(See section 3. Disable direct hazards / safety regulations).
3. Keep away from flammable and explosive materials.

Allowed methods:

1. Towing.  
*Note! Only use front towing eye for towing the vehicle with all wheels on the ground.*
2. Lifting and towing.
3. Transporting.

*Note!*

*If the vehicle must be towed more than 500m!  
Remove the drive shaft flange and the haft shaft from the drive axle.  
(See drivers manual for detailed information)*

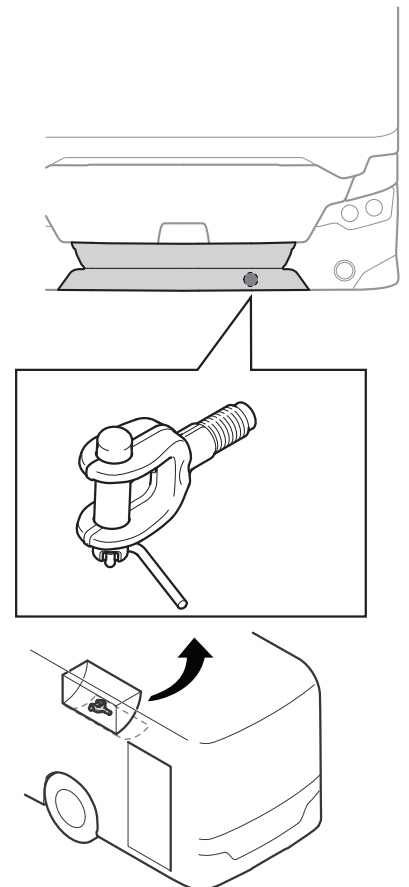

## 9. Important additional information

N/A

## 10. Explanation of pictograms used

N/A