

1. Identifiers

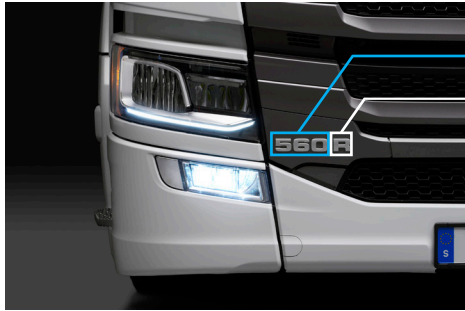

**ENGINE POWER
CAB SIZE**

2. Immobilisation / stabilisation / lifting

1. Activate the parking brake

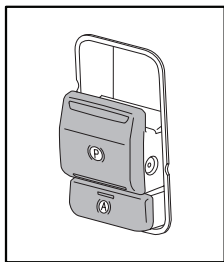

2. Lifting points

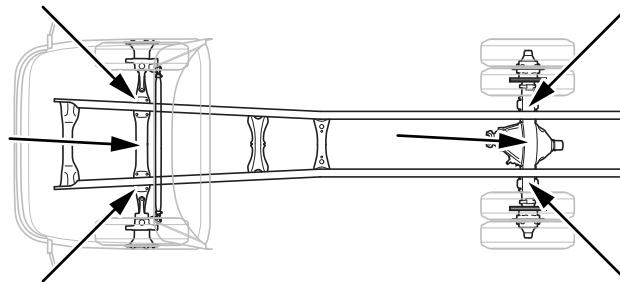

3. Disable direct hazards / safety regulations



The vehicle may be fitted with an internal or external switch for the battery master switch. The external switch is normally red.

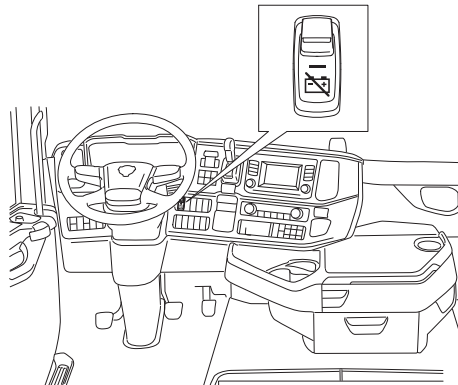

The location of the battery box varies depending on the vehicle equipment. The illustrations show standard positioning (A and B). If the vehicle does not have a battery master switch then the battery must be disconnected to switch off the voltage.

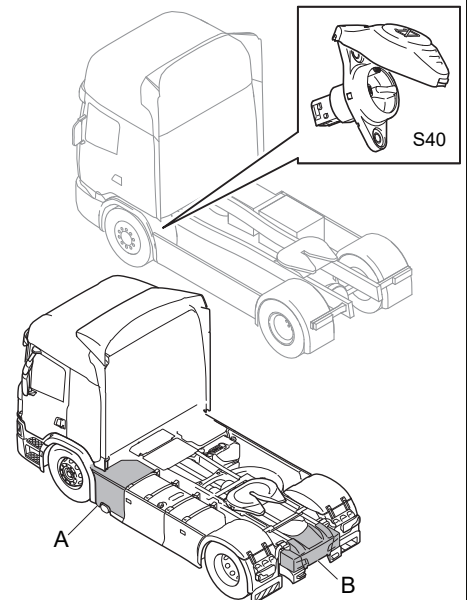

4. Access to the occupants

1. Through driver or passenger door.
2. Break through the side window.

Note! Front windscreen is laminated.

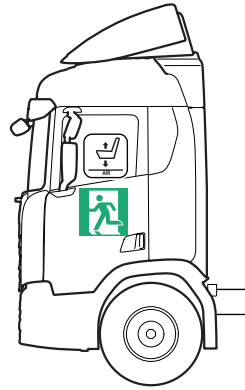
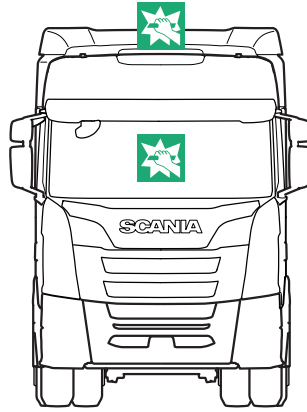

5. Stored energy / liquids / gases / solids

Liquids and gases



6. In case of fire



When fighting the fire with water, any electrical hazards have to be considered and rules have to be respected.



Hydrogen fluoride, carbon monoxide, carbon dioxide can be released.

Wear Self Contained Breathing Apparatus (SCBA) and cover your skin.



Risk of battery re-ignition
(see section 8. Towing / transportation / storage).

II. Fire related to other material



Can occur in the following compartments:
- auxiliary heater.



If other materials are involved, a class ABS fire extinguisher can be used.

7. In case of submersion



If possible:

1. Remove the vehicle from the water.
2. Disable direct hazards (see section 3. Disable direct hazards / safety regulations).



Wear appropriate Personal Protective Equipment (PPE).

8. Towing / transportation / storage

1. The towing eye fastening point is located under the front bumper



2. Shut down the power of the vehicle (See section 3. Disable direct hazards / safety regulations).
3. Keep away from inflammable and explosive materials.

Allowed methods:

1. Towing.

(Note! Use only front towing eye for towing the vehicle with all wheels on the ground).

2. Lifting and towing
3. Transporting

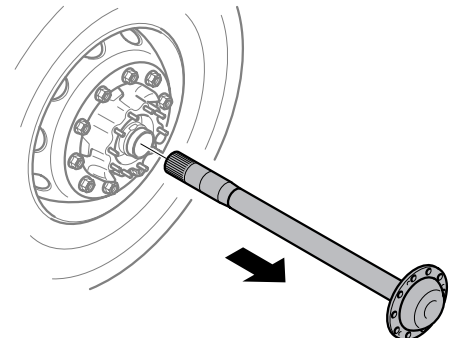
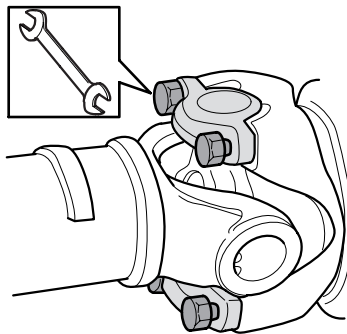
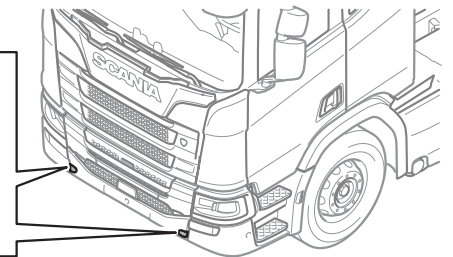
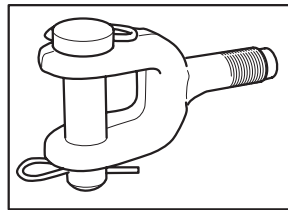

Note!

If the vehicle must be towed or transported more than 500 m, the speed must not exceed 10 km/h. Remove the drive shaft flange and the haft shaft from the drive axle. (See drivers manual for detailed information).

9. Important additional information



See drivers manual or rescue and towing manual for more detailed information

10. Explanation of pictograms used

N/A